



GENERAL MEASURING GUIDELINES FOR ALL POOL SHAPES

- Measuring a pool will be easier if you have another person helping you.
- Draining the pool will also make the process of measuring your pool easier; however, it is not always necessary, as many pools can be measured with water in them.
- **Never assume a pool is standard.** All pools are different. Most importantly, measure the pool for an exact fit. Actual pool measurements should be made even if original pool plans are available, due to the fact that slight variances may have occurred during construction.
- When measuring pools, do not make allowances for weather conditions, temperature, or the fact that vinyl shrinks and expands. These calculations are made when the new liner is designed.
- Supply all measurements in feet and inches, rounding up to the **nearest quarter-inch on liner-covered features**, such as steps, ledges, and benches, and rounding up to the **nearest half-inch** on all other measurements.
- Follow the “step-by-step” measuring instructions carefully, referring to all diagrams to ensure accurate measurements.
- Remember to include your name, mailing address, phone and fax numbers, and email address on each page that you send to Branded Manufacturing. You must also sign off on an approval drawing of the liner before we can begin building the liner.
- Remember to record all of your measurements and place them in the proper lines/boxes on the proper form(s). You may need to transfer measurements you have made on the “MEASURING INSTRUCTIONS” pages onto the actual measuring form.
- Write your measurements legibly, using BLACK INK. (NO PENCIL OR FELT-TIP MARKER, PLEASE!) Make copies of all pages for your records before sending them to us. You will need to refer to your copies if we have questions regarding your measurements.
- When in doubt, give us a call at (731) 345-4500.

ONLY THE BEST GET BRANDED

MEASURING INSTRUCTIONS - STEP-BY-STEP

LAZY-L ("ELL") POOLS

STEP #1: MEASURE THE OUTER WIDTHS AND THE LENGTHS

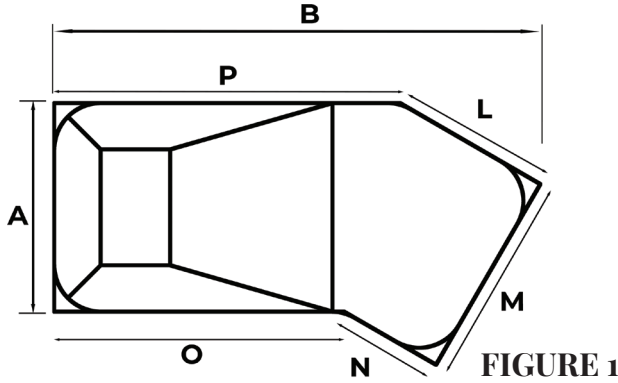

Referring to the illustration of your Lazy-L pool (Figure 1), be sure that measurements A, B, L, M, N, O, and P are made at the bead receiver (where the liner snaps into the track), not at the edge of the coping (the edge of the pool deck). See Figure 2.

INDICATE IF THE ELL IS TO THE RIGHT OR LEFT.
STANDING IN THE SHALLOW END ELL, IS THE DEEP
END ON THE LEFT OR RIGHT?

RECORD MEASUREMENTS ON THE MEASURING FORM.

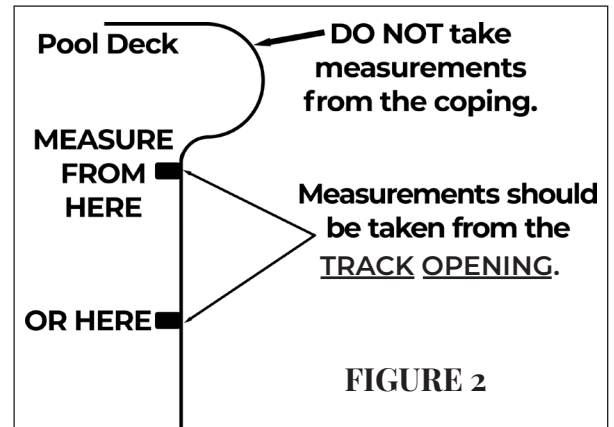

STEP #2: MEASURE THE CORNER DIAGONALS

For a Lazy-L pool, you will need to measure the diagonals (#1, #2, #3, #4, & #5). Refer to Figure 3 to locate the diagonals. Remember to use the bead receiver (pool edge) as the reference point. The diagonals are often overlooked, but they are important, **ESPECIALLY ON A LAZY-L**, as few pools are perfectly square. There can be a substantial difference end-to-end in a pool, and that needs to be noted if a liner is to fit properly. (The Computer-Aided-Design system that engineers your liner can adjust for out of square pools.)

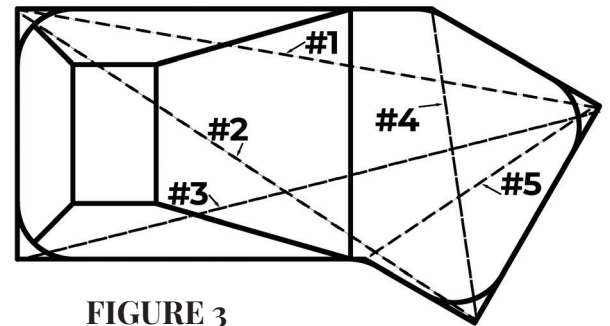

Imaginary Lines

Imaginary Lines

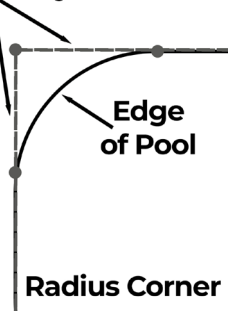
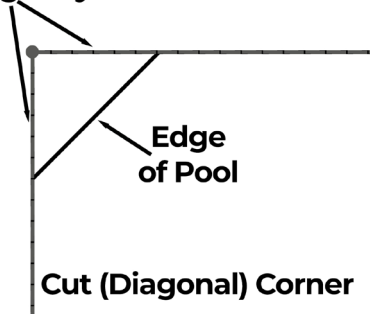

Measure the diagonals from the squared corners. If the corners of your pool are rounded (radius) or cut (diagonal), be sure to measure to squared corners. Refer to the diagrams (Figure 4) for instruction on measuring to the squared corners.

FIGURE 4

RECORD MEASUREMENTS ON THE MEASURING FORM.

STEP #3: MEASURE THE DIMENSIONS (HORIZONTALLY AND VERTICALLY)

Choose the bottom contour of your pool from the illustration shown in Figure 5 to determine which measurements you will need to take.

HOW DO I MEASURE THE BOTTOM OF THE POOL?

You will be able to make horizontal measurements of the pool bottom without entering the pool. Taking these measurements is easier than you may think when you use this easy-to-make measuring tool.

You will need:

- 1) A long, straight pole (telepole, pool pole, or equivalent)
- 2) String attached to the end of the pole
- 3) Some sort of weight tied to the other end of the string, such as a plumb bob
- 4) A measuring tape

Follow the instructions below, using your “fishing pole”, to make these measurements.

Horizontal Bottom Measurements

Use your “fishing pole” to “fish” for a point on the bottom of the pool. With the pole parallel to the ends of the pool and the string vertical (allow no slack in the string), measure the distance from the edge of the pool (water’s edge) to the desired measurements based on the bottom contour of your pool.

For example, to take measurement I or K, you would stand on one side of the pool, and “fish” for a corner of the hopper. You would then measure the distance from the edge of the pool (pool wall) to the end of the pole where the string is attached.

Depth Measurements

When taking the depth measurements (C and D), be sure to measure from the bottom of the pool floor to the bead receiver. Do not measure to the top of the pool; otherwise, your measurement will be incorrect.

Be sure you are NOT measuring a slope when taking horizontal bottom measurements. We only use measurements parallel to the deck.

RECORD MEASUREMENTS ON THE MEASURING FORM.

DOUBLE CHECK YOUR MATH TO ENSURE THE LENGTHS EQUAL MEASUREMENT B AND THE END VIEW MEASUREMENTS EQUAL A. IF THEY DO NOT, THE POOL AND/OR THE LINER WILL BE OUT OF SQUARE.

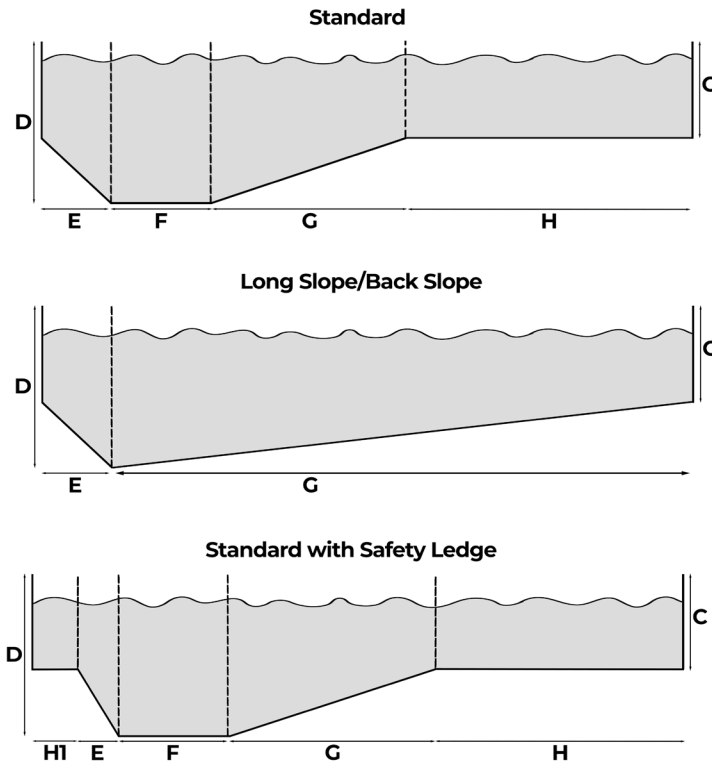

Record the measurements is as if you are in the shallow end looking at the deep end.

FIGURE 5

STEP #4: MEASURE THE CORNERS

Corner measurements/indicators must be specified on the MEASURING FORM.

- Square corners do not require additional measurement.
- Cut (diagonal) corners must be measured. Refer to Figure 6.
- Radius corners must be squared. Use two straight edges to form an imaginary square corner, and mark where the edges meet as Point 1. Measure the imaginary corner (Point 1) to Point 2. Refer to the illustration in Figure 7.

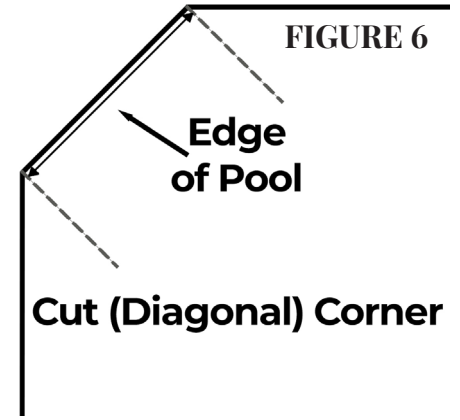

STEP #5: MEASURE ANY FEATURES THAT WILL BE COVERED IN VINYL, INCLUDING STEPS, BENCHES, AND LEDGES.

If your pool has built-in steps, benches, or ledges that are covered with vinyl, you must complete the separate MEASURING FORM for Vinyl Covered Features.

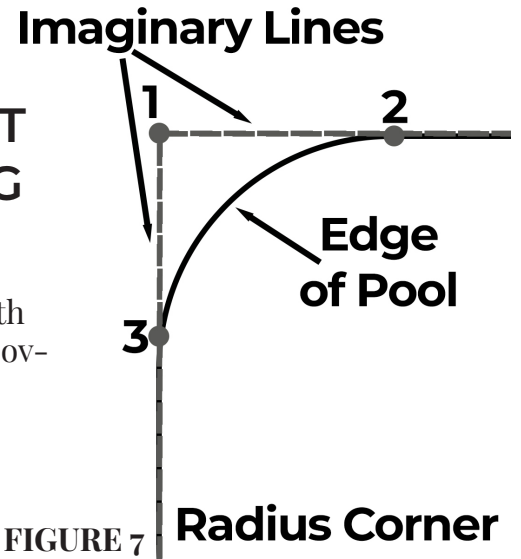

STEP #6: INDICATE WALL SEAM PLACEMENT

By default, the wall seam placement is in the center of the shallow end. However, if the pool has steps in a different location, the wall seam can be placed in the center of the step. Indicate on the MEASURING FORM where the seam should be located if other than the center shallow end.

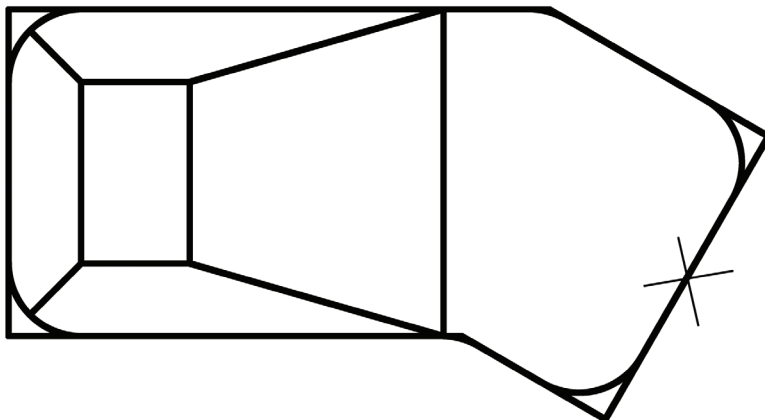

RECORD MEASUREMENTS ON THE MEASURING FORM.

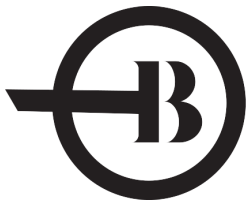

BRANDED MANUFACTURING

B R A N D E D M F G . C O M

MEASURING FORM - LAZY-L

COMPANY/NAME: _____
 ADDRESS: _____
 CITY: _____ STATE: _____ ZIP: _____
 PHONE (Cell): _____ PHONE (Work): _____
 FAX: _____ EMAIL: _____

LINER DESCRIPTION: _____
 PATTERN: _____ MIL: _____ BEAD TYPE: _____

DIMENSIONS (see page 2-3)

LAZY-L: LEFT or RIGHT (circle one)

A (Width): _____
 B (Length): _____
 Diagonal #1: _____
 Diagonal #2: _____
 Diagonal #3: _____
 Diagonal #4: _____
 Diagonal #5: _____
 C (Wall Height): _____
 D (Depth): _____
 E (Back Slope): _____
 F (Hopper Length): _____
 G (Long Slope): _____
 H (Shallow End): _____
 I (Left Side Slope*): _____
 J (Hopper Width): _____
 K (Right Side Slope*): _____
 L (Shallow Length): _____
 M (Shallow Wall Width): _____
 N: (Shallow Short Length): _____
 O: (Deep End Short Length): _____
 P: (Deep End Long Length): _____
 H₁ (Safety Ledge): _____

CORNER TYPE (see page 4)

Square (90°)
 Cut (Diagonal) Size: _____
 Radius (Rounded) Size: _____

INDICATE WALL SEAM LOCATION AND/OR LOCATION OF STEPS

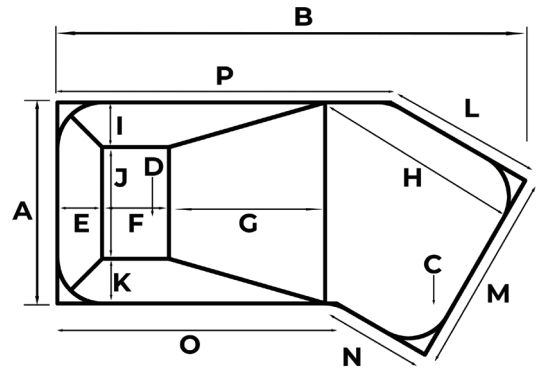

COMMENTS

POOL LOCATION ADDRESS (REQUIRED)

P.O. #: _____
 Signature: _____

Your signature indicates that you have verified your measurements and that the information you have provided is correct.

VINYL-COVERED STEPS?

Please attach additional measuring forms.

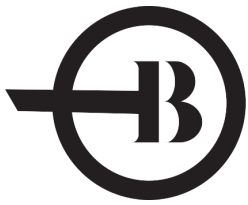

BRANDED MANUFACTURING

B R A N D E D M F G . C O M

MEASURING FORM - EXTERNAL IN-GROUND VINYL STEPS

COMPANY/NAME: _____

ADDRESS: _____

CITY: _____ STATE: _____ ZIP: _____

PHONE (Cell): _____ PHONE (Work): _____

FAX: _____ EMAIL: _____

A BACK CORNERS (follow procedures from Step 4)

Square (90°)

Cut (Diagonal) Size: _____

Radius (Rounded) Size: _____

B RECESS CORNERS

Square (90°)

Cut (Diagonal) Size: _____

Radius (Rounded) Size: _____

C STEP LOCATION

Indicate on the picture where the steps are located with measurements from the squared corners.

D DEPTH AND WIDTH

Measure the total width and depth of the stairs. Include the depth of the recess.

Width: ___ ft ___ in Depth: ___ ft ___ in

E RISERS AND TREADS

Measure riser heights and tread depths.

R1: _____ T1: _____

R2: _____ T2: _____

R3: _____ T3: _____

R4: _____ T4: _____

R5: _____

F Do you need rod pockets to secure steps?

Yes No

POOL LOCATION ADDRESS (REQUIRED)

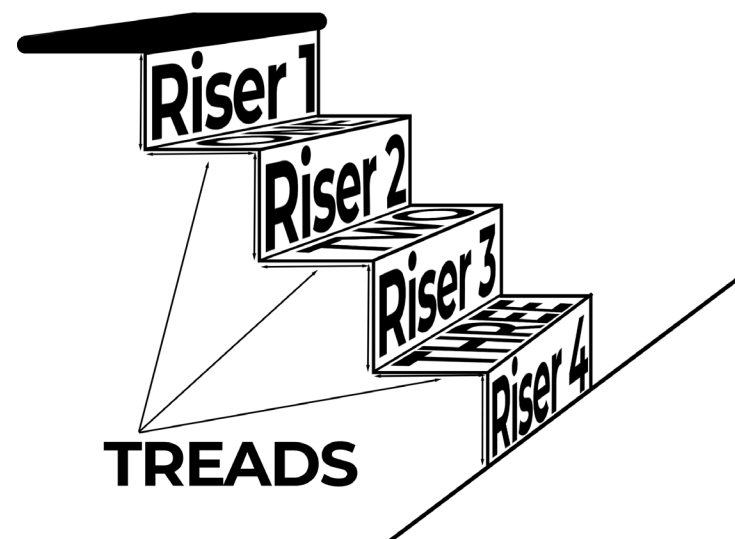
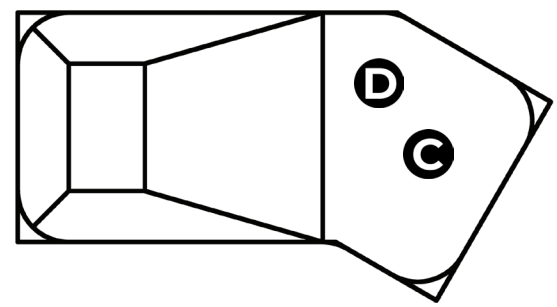
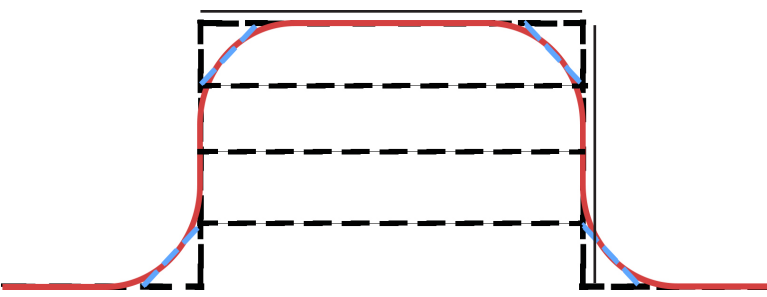

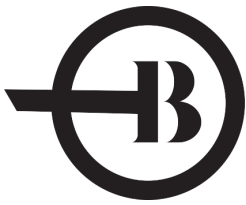

BRANDED MANUFACTURING

B R A N D E D M F G . C O M

MEASURING FORM - INTERNAL IN-GROUND VINYL STEPS

COMPANY/NAME: _____

ADDRESS: _____

CITY: _____ STATE: _____ ZIP: _____

PHONE (Cell): _____ PHONE (Work): _____

FAX: _____ EMAIL: _____

A STEP STYLE PLEASE PROVIDE DETAILED MEASUREMENTS!

Full Width

Corner

Wedding Cake

Step/Bench Combo

Specialty/Custom/Other

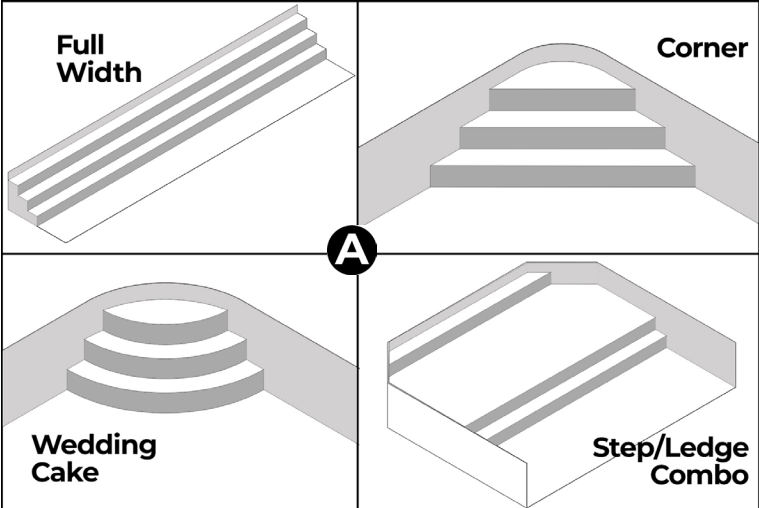

B Indicate where the stairs are located.

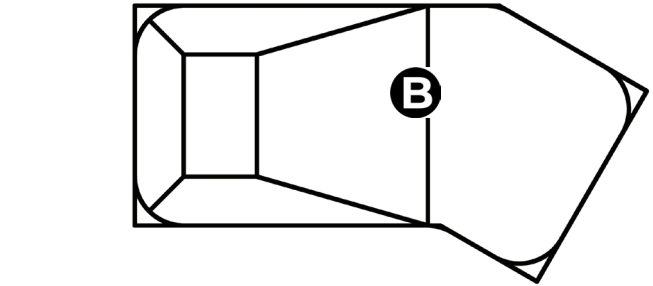

C RISERS AND TREADS
Measure riser heights and tread depths.

R1: _____ T1: _____

R2: _____ T2: _____

R3: _____ T3: _____

R4: _____ T4: _____

R5: _____

D Please add additional information or comments below.

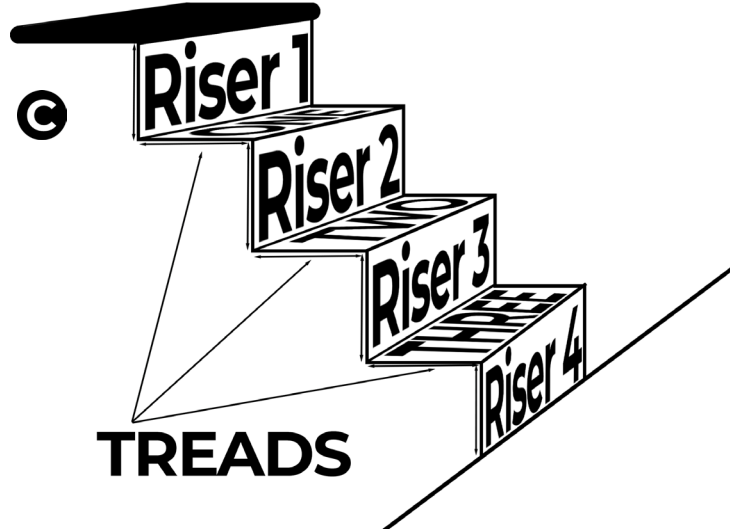

POOL LOCATION ADDRESS (REQUIRED)

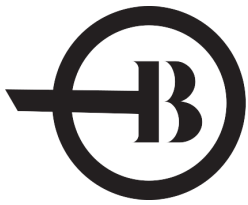

BRANDED MANUFACTURING

B R A N D E D M F G . C O M

MEASURING FORM - VINYL-COVERED BENCHES/LEDGES

COMPANY/NAME: _____

ADDRESS: _____

CITY: _____ STATE: _____ ZIP: _____

PHONE (Cell): _____ PHONE (Work): _____

FAX: _____ EMAIL: _____

A BENCH LOCATION

Indicate where the bench is located on the drawing. Include measurements from squared corners on both sides.

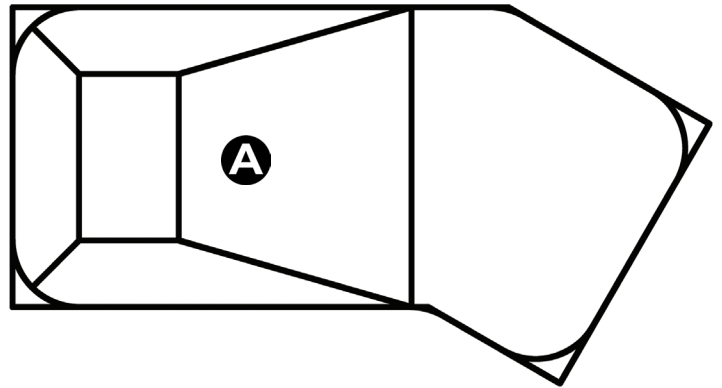

B RISERS AND TREADS

Measure riser heights and tread depths.

R1: _____ T1: _____

R2: _____ T2: _____

R3: _____ T3: _____

R4: _____ T4: _____

R5: _____

C Please add additional information (such as corner measurements) or comments below.

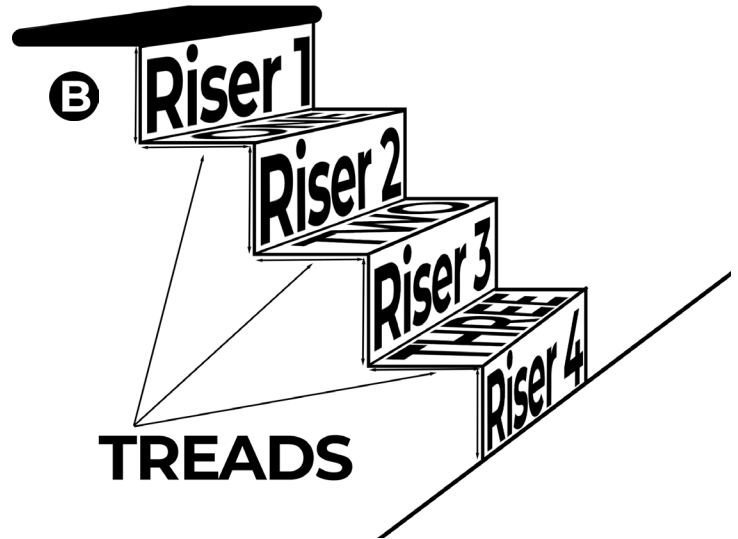

POOL LOCATION ADDRESS (REQUIRED)

ONLY THE BEST GET BRANDED